





# NOVEMBER 2023



| SUN | MON                                                     | TUE | WED                                        | THU                                                                                                                         | FRI                                         | SAT                                                                                                          |
|-----|---------------------------------------------------------|-----|--------------------------------------------|-----------------------------------------------------------------------------------------------------------------------------|---------------------------------------------|--------------------------------------------------------------------------------------------------------------|
|     |                                                         |     | 1<br>Ped. Day<br>No School<br>Daycare Open | 2<br>Cycle 2<br>Fieldtrip to the<br>OSM  | 3                                           | 4                                                                                                            |
| 5   | 6<br>Home & School<br>and Grad.<br>Committee<br>6:00 PM | 7   | 8                                          | 9                                                                                                                           | 10<br>Remembrance<br>Day Assembly           | 11<br>Remembrance<br>Day  |
| 12  | 13<br>Governing<br>Board 6:30 PM                        | 14  | 15                                         | 16<br>Grade 5:<br>Alvéole<br>Workshop   | 17<br>Virtue of the<br>Month<br>Assembly    | 18                                                                                                           |
| 19  | 20                                                      | 21  | 22                                         | 23<br>Parent Teacher<br>Conferences<br>No School<br>Daycare Open                                                            | 24<br>Ped. Day<br>No School<br>Daycare Open | 25                                                                                                           |
| 26  | 27                                                      | 28  | 29                                         | 30<br>Open House                                                                                                            |                                             |                                                                                                              |

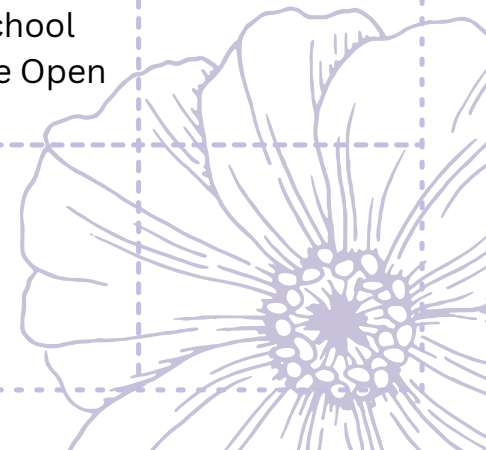
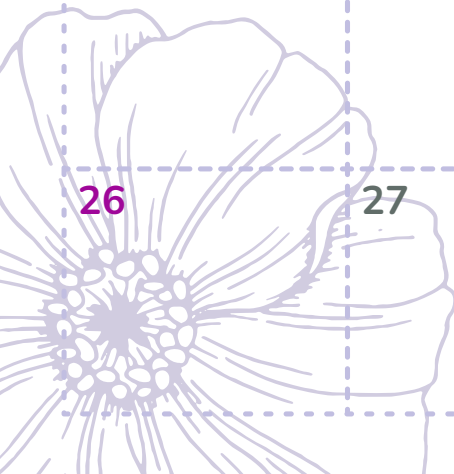



# MUSTANG NEWS NOVEMBER EDITION

## 1.

### CHESS & CHECKERS CLUB

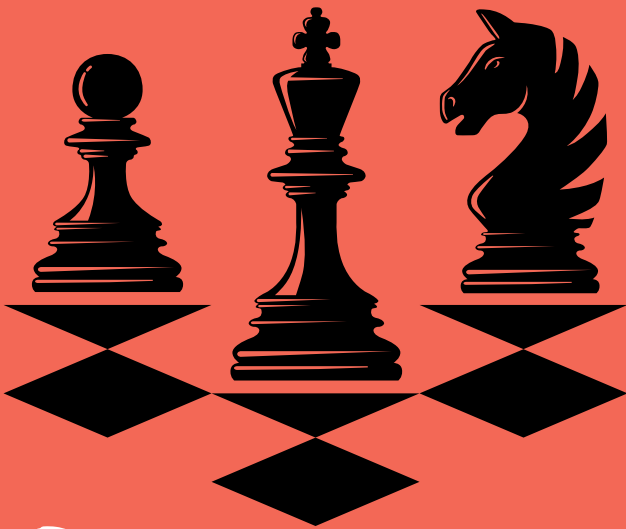

Grades: 3, 4, 5 & 6

Who: Mr. Peter & Mr. Andrew

When? Mondays at Lunch

Starting Date: November 6th.

Where: Daycare Room

Interested students have received a permission form, please return it by Friday Nov. 3rd if they wish to attend.

Please note, that if this activity conflicts with PELO, they will not be able to sign up for this session.

## 2.

### STORY TIME CLUB

Grades: 1 & 2

Who: Mr. Peter & Mr. Andrew

When? Tuesdays during afternoon recess

Starting Date: November 7th.

Where: Library

All students have received a permission form, please return it by Friday Nov. 3rd if they wish to attend.



3.

## AFTERSCHOOL ACTIVITIES

Registration for after school activities has started. Please take a look at the email sent Monday October 30th.

If you are interested in registering for any of the activities, you may do so by following this link:

[Enfant & Compagnie - Programs :  
Honore Mercier Elementary School](#)



4.

## CHOCOLATE DRIVE

Reminder that the chocolate drive will end on Friday, November 3rd, 2023.

Payments for the total number of boxes sold can be made into one cheque. Should you be unable to sell the full box, please return the unsold chocolates to school with the payment for those you have sold by November 3rd.

To simplify payment and if possible, we would appreciate a cheque made payable to Honoré Mercier Home & School Association, and returned to the school in an envelope addressed to Home & School including your child's name and homeroom number.

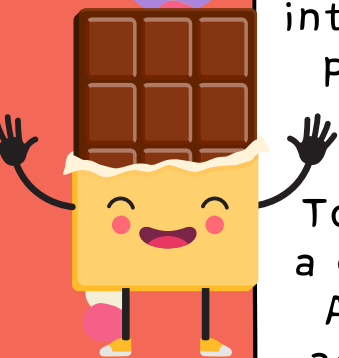

5.

## REMEMBRANCE DAY

We will be having a Remembrance Day Ceremony on Friday, November 10th.



6.

## PHYS. ED.

K4/5 & Cycle 1: We are currently playing different games that help develop gross motor skills & spatial awareness by learning to move in various ways.

Cycles 2 & 3: Now that our gymnastics unit has ended, we have started learning the skills required to play volleyball. The goal being able to play games by the end of the unit

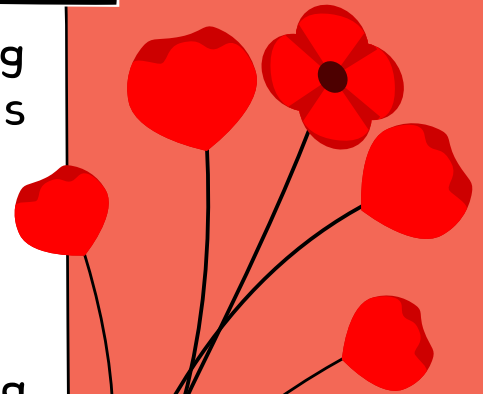

## MUSIC

All grades will soon begin working on their Holiday Concert material! Look forward to more information

7.

# K5 STEAM PROJECT

Exploring pumpkins outside and inside (how they look, feel, smell) & incorporating math, science and art.

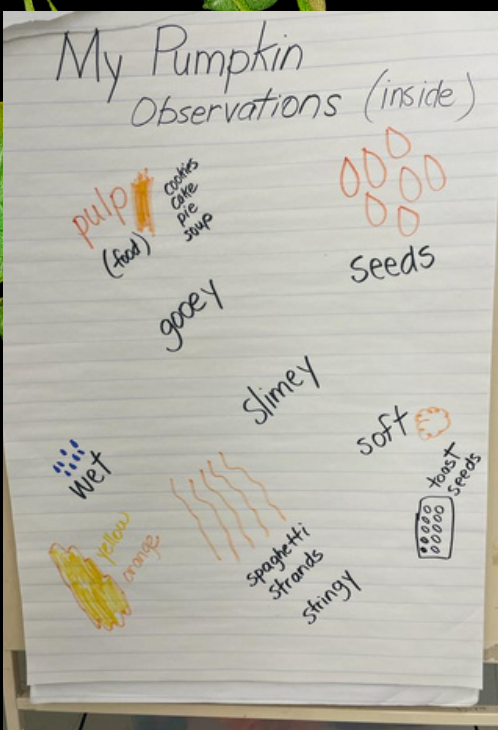

# 9. WHAT WILL SEKO BE?

Grade 1 had fun guessing what Seko's Halloween costume would be!



# HAUNTED HOUSE 10.

Thank you to all of our Parent Volunteers for this year's spooktacular Haunted Hospital!

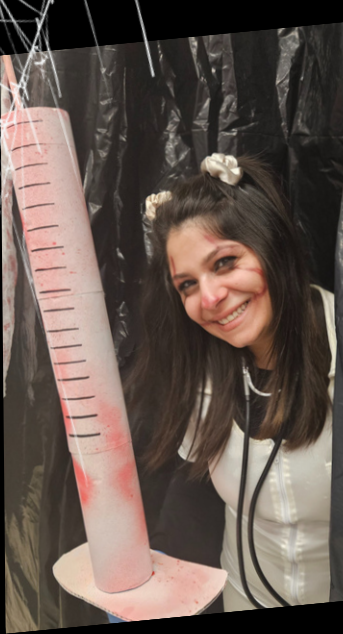
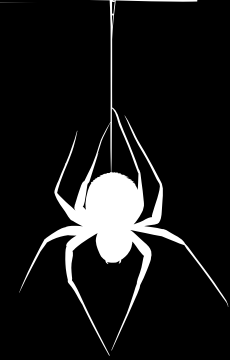

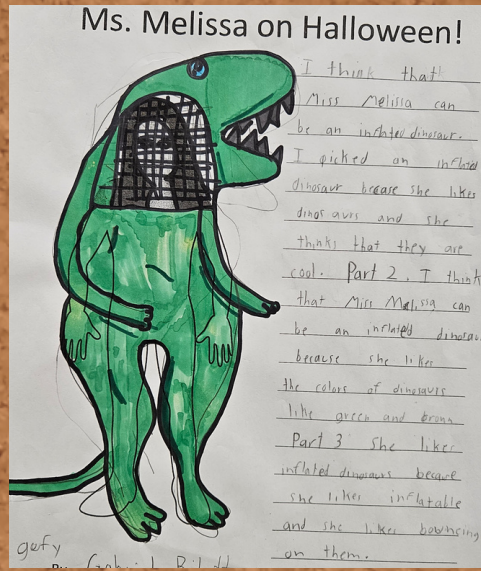
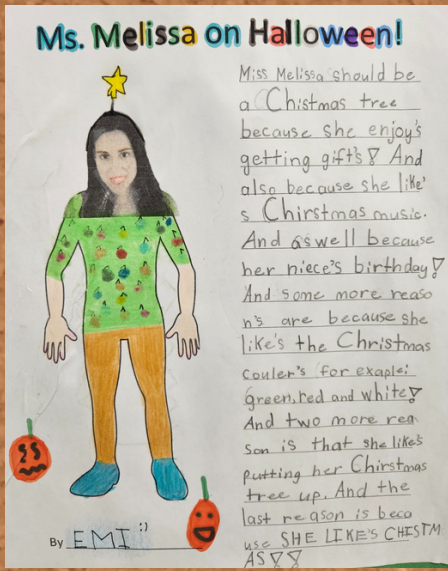
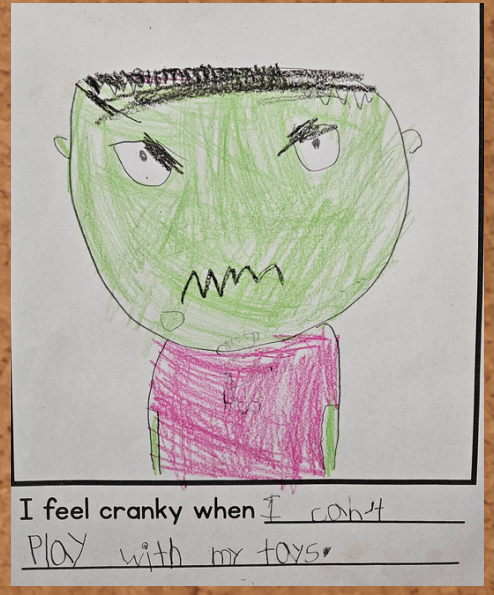
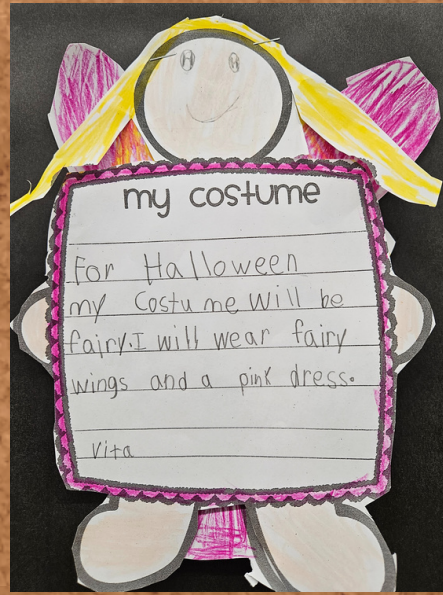
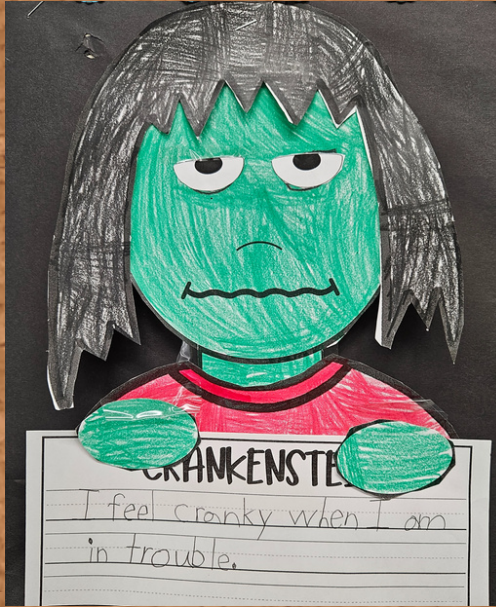
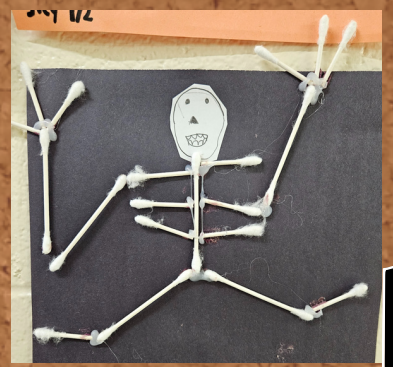

H A L L O W E E N H A L L W A Y A R T